

TSYS01 Digital Temperature Sensor



- High Accuracy Temperature Sensor
- 16/24 bit Resolution
- Low Power
- SPI/I²C Interface
- QFN16 Package

DESCRIPTION

The TSYS01 is a single chip, versatile, new technology temperature sensor. The TSYS01 provides factory calibrated temperature information. It includes a temperature sensing chip and a 24 bit $\Delta\Sigma$ -ADC. The essence of the digital 24 bit temperature value and the internal factory set calibration values lead to highly accurate temperature information accompanied by high measurement resolution.

The TSYS01 can be interfaced to any microcontroller by an I²C or SPI interface. This microcontroller has to calculate the temperature result based on the ADC values and the calibration parameters.

The basic working principle is:

- Converting temperature into digital 16/24 bit ADC value
- Providing calibration coefficients
- Providing ADC value and calibration coefficients by SPI or I²C interface.

FEATURES

High Accuracy $\pm 0.1^\circ\text{C}$ @ Temp.: $-5^\circ\text{C} \dots +50^\circ\text{C}$
 Adjustment of high accuracy temp. range on request
 Low Current, $< 12.5 \mu\text{A}$ (standby $< 0.14 \mu\text{A}$)
 SPI / I²C Interface
 Small Package: QFN16
 Operating Temperature Range: $-40^\circ\text{C} \dots +125^\circ\text{C}$

APPLICATIONS

Industrial Control
 Replacement of Thermistors and NTCs
 Heating / Cooling Systems
 HVACR

TSYS01 Digital Temperature Sensor

ABSOLUTE MAXIMUM RATINGS

Absolute maximum ratings are limiting values of permitted operation and should never be exceeded under the worst possible conditions either initially or consequently. If exceeded by even the smallest amount, instantaneous catastrophic failure can occur. And even if the device continues to operate satisfactorily, its life may be considerably shortened.

Parameter	Symbol	Conditions	Min	Typ	Max	Unit
Supply Voltage	V _{DD}		-0.3		+3.6	V
Operating Temperature	T _{op}		-40		+125	°C
Storage temperature	T _{stor}		-55		+150	°C
ESD rating	ESD	Human Body Model (HBM) pin to pin including VDD and GND	-4		+4	kV
Humidity	Hum		Non condensing			

OPERATING CONDITIONS

Parameter	Symbol	Conditions	Min	Typ	Max	Unit
Operating Supply Voltage	V _{DD}	stabilized	2.2		3.6	V
High Accuracy Supply Voltage	V _{DD}	To achieve Acc1	3.2		3.4	V
Supply Current	I _{DD}	1 sample per second			12.5	µA
Standby current	I _S	No conversion, VDD = 3V T = 25°C T = 85°C		0.02	0.14	µA
				0.70	1.40	µA
Peak Supply Current	I _{DD}	During conversion		1.4		mA
Conversion time	T _{CONV}		7.40	8.22	9.04	ms
Serial Data Clock SPI	F _{SCLK}				20	MHz
Serial Data Clock I ² C	F _{SCL}				400	kHz
VDD Capacitor		Place close to the chip	100nF			

OPERATIONAL CHARACTERISTICS

If not otherwise noted, 3.3V supply voltage is applied.

Parameter	Symbol	Conditions	Min	Typ	Max	Unit
Temperature Measurement Range	T _{RANG}		-40		125	°C
Accuracy 1	T _{ACC1}	-5°C < T < +50°C V _{DD} = 3.2V – 3.4V	-0.1		+0.1	°C
Accuracy 2	T _{ACC2}	-40°C < T < +125°C V _{DD} = 3.2V – 3.4V	-0.5		+0.5	°C
PSSR		V _{DD} = 2.7 – 3.6 T = 25°C, C = 100nF			0.2	°C
Temperature Resolution	T _{RES}				0.01	°C
Time Constant	T	t ₁₀₋₉₀ T ₁ =25°C T ₂ =75°C PCB 900mm ² x 1.5mm FR4		9		s
Self Heating	SH ₁	10 samples/s, 60s, still air			0.02	°C

TSYS01 Digital Temperature Sensor

ANALOGUE TO DIGITAL CONVERTER

Parameter	Symbol	Conditions	Min	Typ	Max	Unit
Output Word				24		bit
Conversion Time	t_c		7.40	8.22	9.04	ms

DIGITAL INPUTS (SCLK, SDI, CSB, PS)

Parameter	Symbol	Conditions	Min	Typ	Max	Unit
Input High Voltage	V_{IH}	$V_{DD} = 2.2 \dots 3.6V$	$0.7 V_{DD}$		V_{DD}	V
Input Low Voltage	V_{IL}	$V_{DD} = 2.2 \dots 3.6V$	$0.0 V_{DD}$		$0.3 V_{DD}$	V
CS low to first SCLK rising	t_{CSL}		21			ns
CS high to first SCLK rising	t_{CSH}		21			ns
SDI setup to first SCLK rising	T_{DSO}		6			ns
SDI hold to first SCLK rising	T_{DO}		6			ns

DIGITAL OUTPUTS (SDA, SDO)

Parameter	Symbol	Conditions	Min	Typ	Max	Unit
Output High Voltage	V_{OH}	$I_{Source} = 1mA$	$0.8 V_{DD}$		V_{DD}	V
Output Low Voltage	V_{OL}	$I_{Sink} = 1mA$	$0.0 V_{DD}$		$0.2 V_{DD}$	V
SDO setup to first SCLK rising	t_{QS}		10			ns
SDO hold to first SCLK rising	t_{QH}		0			ns

TSYS01 Digital Temperature Sensor

CONNECTION DIAGRAM

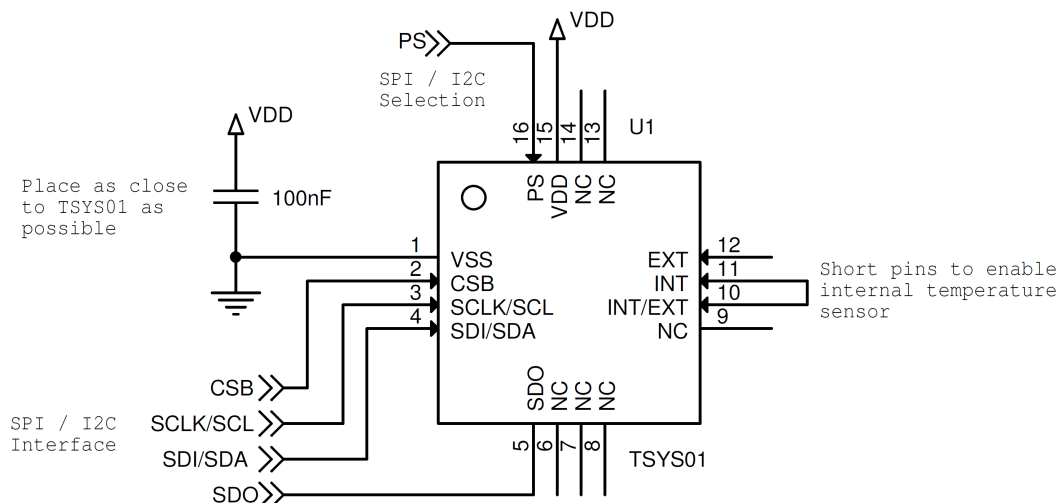

PIN FUNCTION TABLE

Pin	Name	Type	Function
1	VSS	G	Ground
2	CSB	DI	SPI: Chip Select (active low) I ² C: Address Selection
3	SCLK/SCL	DI	SPI: Serial Data Clock I ² C: Serial Data Clock
4	SDI/SDA	DIO	SPI: Serial Data Input I ² C: Data Input / Output
5	SDO	DO	SPI: Serial Data Output
6 – 9	NC	---	Not connected / Do not connect
10	INT / EXT	DI/AI	Internal / External Sensor Selection Internal Sensor: Connect Pin10 with Pin11 External Sensor: Connect external Sensor
11	INT	DI/AI	Internal / External Sensor Selection Internal Sensor: Connect Pin11 with Pin10 External Sensor: Leave Unconnected
12	EXT	DI/AI	Internal / External Sensor Selection Internal Sensor: Leave Unconnected External Sensor: Connect external Sensor
13 – 14	NC	---	Not connected / Do not connect
15	VDD	P	Supply Voltage
16	PS	DI	Communication protocol select (0=SPI, 1=I ² C)

TSYS01 Digital Temperature Sensor

INTERFACE DESCRIPTION

PROTOCOL SELECTION

PS pin input level has to be defined in dependence to protocol selection.

- PS = 0 activates SPI.
- PS = 1 activates I²C.

I²C INTERFACE

A I²C communication message starts with a start condition and it is ended by a stop condition. Each command consists of two bytes: the address byte and command byte.

I²C ADDRESS SELECTION

The I²C address can be selected by CSB pin.

- CSB=1 then the address is 1110110x.
- CSB=0 the address is 1110111x.

Therefore, two TSYS01 can be interfaced on the same I²C bus.

SPI INTERFACE

The serial interface is a 4-wire SPI bus, operating as a slave. CS (chip select), SCLK (serial clock), SDI (serial data in), and SDO (serial data out) are used to interact with the SPI master.

Communication with the chip starts when CS is pulled to low and ends when CS is pulled to high.

SCLK is controlled by the SPI master and idles low (SCLK low on CS transitions, mode 0).

A mode where the clock alternatively idles high is also supported (mode 3).

COMMANDS

The commands are the same for SPI and I²C interface.

There are four commands:

- Reset
- Read PROM (calibration parameters)
- Start ADC Temperature conversion
- Read ADC Temperature result

Command	Hex Value
Reset	0x1E
Start ADC Temperature Conversion	0x48
Read ADC Temperature Result	0x00
PROM Read Address 0	0xA0
PROM Read Address 1	0xA2
PROM Read Address 2	0xA4
PROM Read Address 3	0xA6
PROM Read Address 4	0xA8
PROM Read Address 5	0xAA
PROM Read Address 6	0xAC
PROM Read Address 7	0xAE

TSYS01 Digital Temperature Sensor

RESET SEQUENCE

The Reset sequence has to be sent once after power-on. It can be also used to reset the device ROM from an unknown condition.

SPI

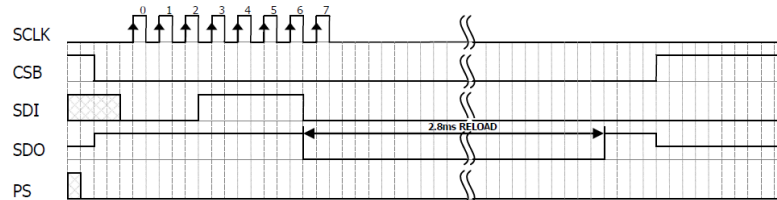

I²C

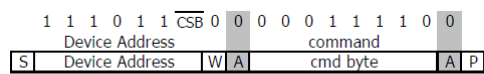

From Master S = Start Condition W = Write A = Acknowledge
 From Slave P = Stop Condition R = Read N = Not Acknowledgement

PROM READ SEQUENCE

The PROM Read command consists of two parts. First command sets up the system into PROM read mode. The second part gets the data from the system.

Below examples are sequences to read address 3 (command 0xA6).

SPI

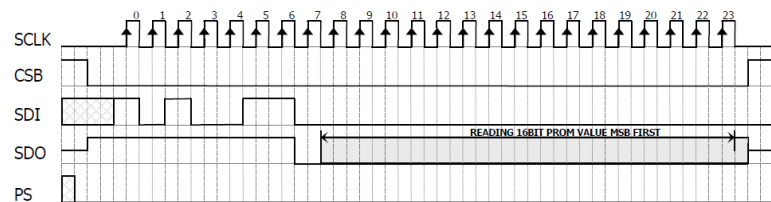

I²C

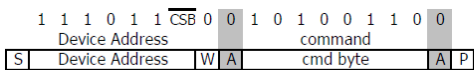

From Master S = Start Condition W = Write A = Acknowledge
 From Slave P = Stop Condition R = Read N = Not Acknowledgement

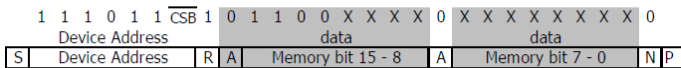

From Master S = Start Condition W = Write A = Acknowledge
 From Slave P = Stop Condition R = Read N = Not Acknowledgement

TSYS01 Digital Temperature Sensor

CONVERSION SEQUENCE

A conversion has to be started by sending this command. The sensor stays busy until conversion is done. When conversion is finished the data can be accessed by using ADC read command

SPI

The last clock will start the conversion which TSYS01 indicates by pulling SDO low. SDO goes high when conversion is completed.

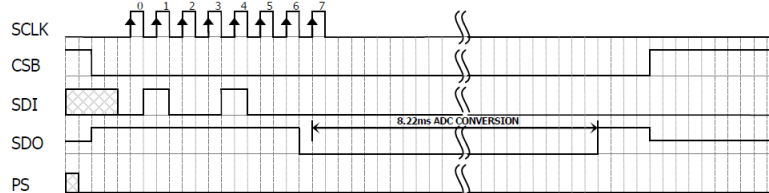

I²C

When the command is sent the TSYS01 stays busy until the conversion is done. All other commands except the reset command will not be executed during this time. When the conversion is finished the data can be accessed by sending a ADC read command, when an acknowledge appears from TSYS01.

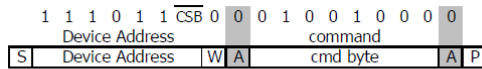

From Master S = Start Condition W = Write A = Acknowledge
 From Slave P = Stop Condition R = Read N = Not Acknowledge

READ ADC RESULT

After the conversion command the ADC result is read using ADC read command. Repeated ADC read commands, or command executed without prior conversion will return all 0 as result.

SPI

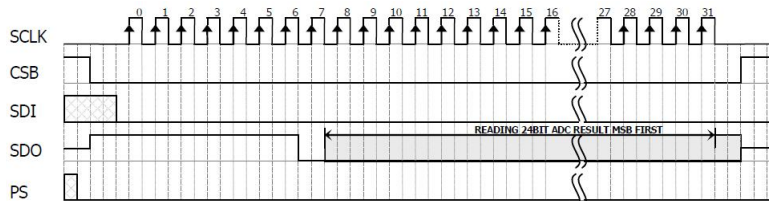

I²C

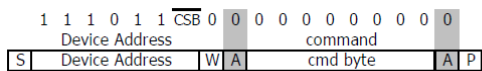

From Master S = Start Condition W = Write A = Acknowledge
 From Slave P = Stop Condition R = Read N = Not Acknowledge

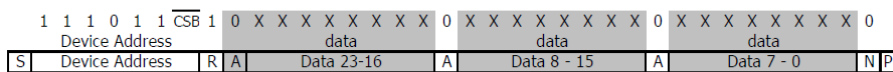

From Master S = Start Condition W = Write A = Acknowledge
 From Slave P = Stop Condition R = Read N = Not Acknowledge

TSYS01 Digital Temperature Sensor

TEMPERATURE CALCULATION

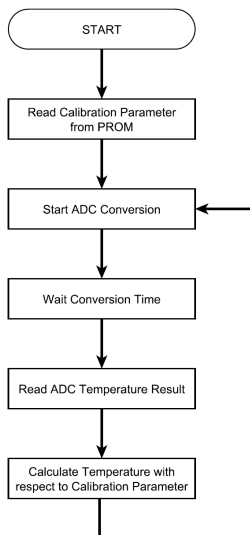

CALIBRATION PARAMETER

Variable	Description	Command	Size / bit	Min	Max	Example
k ₄	Coefficient k ₄ of polynomial	0xA2	16	0	65535	28446
k ₃	Coefficient k ₃ of polynomial	0xA4	16	0	65535	24926
k ₂	Coefficient k ₂ of polynomial	0xA6	16	0	65535	36016
k ₁	Coefficient k ₁ of polynomial	0xA8	16	0	65535	32791
k ₀	Coefficient k ₀ of polynomial	0xAA	16	0	65535	40781

TEMPERATURE POLYNOMIAL

ADC24: ADC value
ADC16: ADC24 / 256

$$T / ^\circ\text{C} = (-2) \cdot k_4 \cdot 10^{-21} \cdot \text{ADC}16^4 + 4 \cdot k_3 \cdot 10^{-16} \cdot \text{ADC}16^3 + (-2) \cdot k_2 \cdot 10^{-11} \cdot \text{ADC}16^2 + 1 \cdot k_1 \cdot 10^{-6} \cdot \text{ADC}16 + (-1.5) \cdot k_0 \cdot 10^{-2}$$

EXAMPLE

ADC24: 9378708
ADC16: 9378708 / 256 = 36636

$$T / ^\circ\text{C} = (-2) \cdot 28446 \cdot 10^{-21} \cdot 36636^4 + 4 \cdot 24926 \cdot 10^{-16} \cdot 36636^3 + (-2) \cdot 36016 \cdot 10^{-11} \cdot 36636^2 + 1 \cdot 32791 \cdot 10^{-6} \cdot 36636 + (-1.5) \cdot 40781 \cdot 10^{-2}$$

$$T / ^\circ\text{C} = \underline{10.55}$$

TSYS01 Digital Temperature Sensor

DIMENSIONS

BOTTOM VIEW

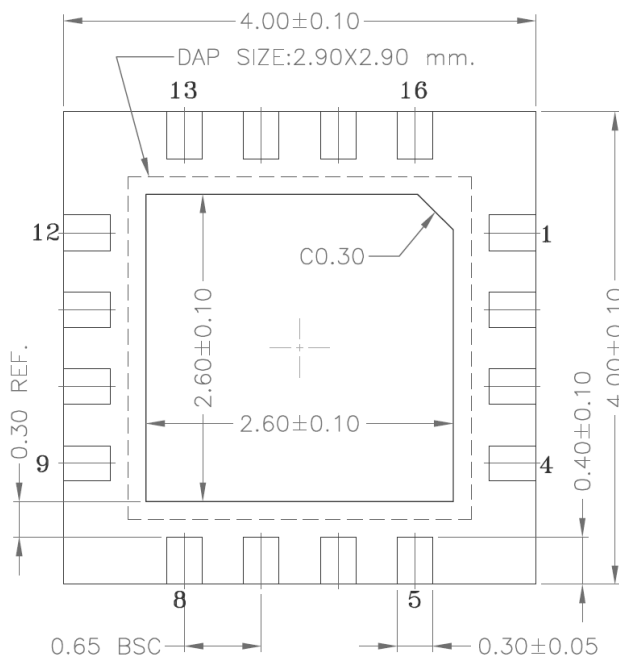

SIDE VIEW

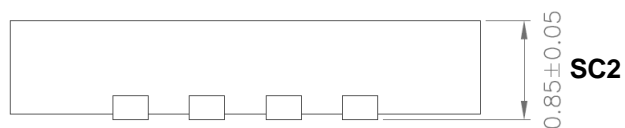

SC: Special Characteristic, tested while production

MARKING

Line	Description	Example
1	Manufacturer	MEAS
2	Product Name	TSYS01
3	Pin 1 Dot, Date Code YYWW	1141

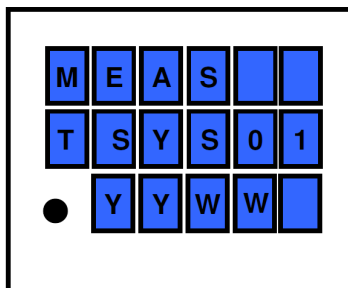

TSYS01 Digital Temperature Sensor

ORDER INFORMATION

Please order this product using following:

Part Number	Part Description
G-NICO-018	TSYS01 Digital Temperature Sensor

EMC

Due to the use of these modules for OEM application no CE declaration is done.

Especially line coupled disturbances like surge, burst, HF etc. cannot be removed by the module due to the small board area and low price feature. There is no protection circuit against reverse polarity or over voltage implemented.

The module will be designed using capacitors for blocking and ground plane areas in order to prevent wireless coupled disturbances as good as possible.

DEFINITIONS AND DISCLAIMERS

- Application information – Applications that are described herein for any of these products are for illustrative purpose only. MEAS Deutschland GmbH makes no representation or warranty that such applications will be suitable for the specified use without further testing or modification.
- Life support applications – These products are not designed for use in life support appliances, devices, or systems where malfunctions of these products can reasonably be expected to result in personal injury.
MEAS Deutschland GmbH customers using or selling this product for use in such applications do so at their own risk and agree to fully indemnify MEAS Deutschland GmbH for any damages resulting from such improper use or sale.

TECHNICAL CONTACT INFORMATION

NORTH AMERICA	EUROPE	ASIA
Measurement Specialties, Inc. 1000 Lucas Way Hampton, VA 23666 Tel: 1-800-555-1551 Fax: 1-757-766-4297 Email: sales@meas-spec.com Web: www.meas-spec.com	Europe MEAS Deutschland GmbH Hauert 13, D-44227 Dortmund, Germany Phone: +49-(0)231-9740-0 Fax: +49-(0)231-9740-20 Email: info.de@meas-spec.com Web: www.meas-spec.com	Measurement Specialties China Ltd. No. 26, Langshan Road, Shenzhen High-tech Park (North) Nanshan District, Shenzhen, China 518107 Phone: +86-755-33305088 Fax: +86-755-33305099 Email: info.cn@meas-spec.com Web: www.meas-spec.com

The information in this sheet has been carefully reviewed and is believed to be accurate; however, no responsibility is assumed for inaccuracies. Furthermore, this information does not convey to the purchaser of such devices any license under the patent rights to the manufacturer. Measurement Specialties, Inc. reserves the right to make changes without further notice to any product herein. Measurement Specialties, Inc. makes no warranty, representation or guarantee regarding the suitability of its product for any particular purpose, nor does Measurement Specialties, Inc. assume any liability arising out of the application or use of any product or circuit and specifically disclaims any and all liability, including without limitation consequential or incidental damages. Typical parameters can and do vary in different applications. All operating parameters must be validated for each customer application by customer's technical experts. Measurement Specialties, Inc. does not convey any license under its patent rights nor the rights of others.